

A

B

C

D

E

F

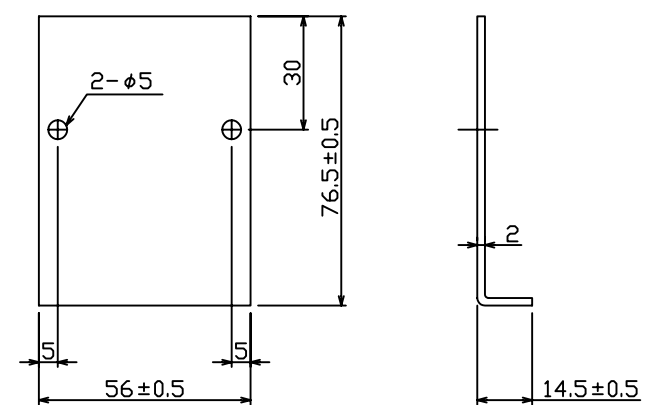

TYPE : GBC-SW1

材質 : 塩ビ
色 : 透明

DESIGNED BY Hatakeyama	CHECKED BY Wakasugi	APPROVED BY - DATE Tarao 2006/11/28	Date 2006/11/28	SCALE 1/2
株式会社 コムテック		NAME AND TYPE 誤操作防止用透明カバー 穴加工有り GBC-SW1		
		TITLE 外形図		DRAWING NUMBER GBC-SW1-V1

単位:mm

REVNO	REVISION NOTE	DATE
1		
2		
3		
4		



5 6 7 8